



OPERATING TABLE ACCESSORIES CATALOGUE

VER. 3

 **Belmont**

FOR ARM SUPPORT

ARM BOARD



1. AT-OPT-AT (1pc/order)

Responded to 50mm thick mattress, black leather, easy attachment and detachment, smooth angle adjustment by pulling a lever under the mattress

RAISED ARM BOARD



2. AT-OPT-G (1pc/order)

Easy to fix the arm with the strap, to tilt the board by the ball - socket joint universal clamp inc.

WRIST HOLDER

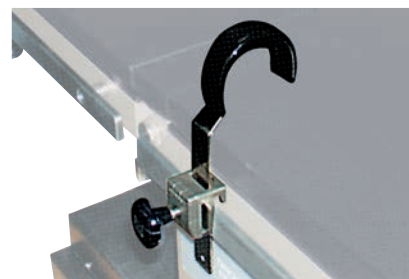

3. AT-OPT-AW (1pc/order)

The arm's height and position adjustable vertical clamp inc.

BRACHIUM ARM BOARD



4. AT-OPT-AHA (1pc/order)

Height adjustable with universal clamp, fixed on the side rail, easy positioning of brachium universal clamp inc.



5. AT-OPT-AHB (1pc/order)

Height adjustable with universal clamp, fixed on the side rail, easy positioning of brachium universal clamp inc.



6. AT-OPT-AHZ (1pc/order)

Black leather, height adjustable, direction adjustable with two clamps universal clamp inc.

ARM BOARD

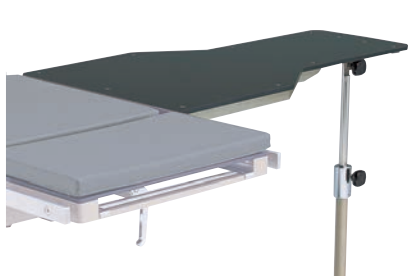

7. AT-OPT-AI (1pc/order)

Translucent arm board with support bar (Large size)

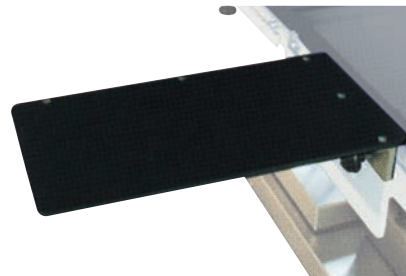

8. AT-OPT-AIS (1pc/order)

Translucent arm board, attachable to the side rail (Small size)

FOR LEGS SUPPORT

STIRRUPS

Bel Flex



1. DR-OPTM-CFXC (1pc/order)
The cart for Bel Flex



2. DR-OPT-CFX (1pair/order)
Flexible movement with the handles, adjustable to all the directions, the Clamshell Pad comfortably covers the patient's foot, and secures the positioning

KNEE CRUTCHES



3. AT-OPT-CN (1pair/order)
Knee crutch with strap, adjustable to any direction via the ball joint universal clamp inc.

KNEE SUPPORT



4. AT-OPT-S (1pc/order)
Foot shield, protect and comfortably support both legs during the surgery vertical clamp inc.

KNEE SUPPORT SPLIT TYPE



5. AT-OPT-W (1pair/order)
Foot shield, split type vertical clamp inc.

FOR BODY SUPPORT

LATERAL SUPPORT



1. AT-OPT-E (1pc/order)

Fixed firmly on the side rail via clamp, support the patient's body with the curved pad vertical clamp inc.

LATERAL SUPPORT UNIVERSAL TYPE



2. AT-OPT-EN (1pc/order)

Rotatable pad via the ball and socket joint, securely and flexibly support the patient's body, vertical clamp inc.

SHOULDER SUPPORT



3. AT-OPT-DN (1pair/order)

Height and width adjustable, provide comfortable support to the shoulder vertical clamp inc.

EXTENSION BOARD

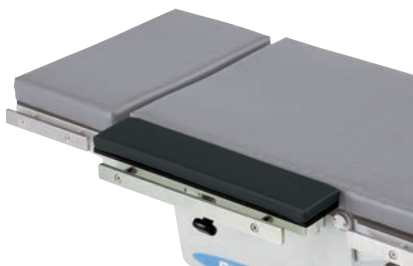

4. AT-OPT-EWB (1pc/order)

Wide extension board, attachable to side rail

BODY STRAIT STRAP



5. AT-OPT-YKA/YKB (1pc/order) (5×180cm)/(10×180cm)

Attachable to the side rail, firmly fasten patient's body, YK100(10×100cm)/YK150(10×150cm)/YK200(10×200cm)/YK250(10×250cm)

CUSHION SUPPORT



6. AT-OPT-PA (1pc/order)

Rectangle shaped, support various parts of body



7. AT-OPT-PB (1pc/order)

Trapezoid shaped, support various parts of body

KIDNEY ELEVATOR

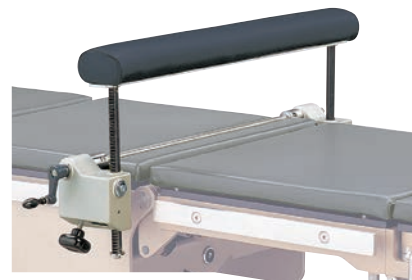

8. AT-OPT-F (1pc/order)

Attachable to side rail

FOR HEAD SUPPORT

GENERAL PURPOSE HEAD SUPPORT



1. AT-OPT-H (1pc/order)

Attachable headrest to the operating table, angle and height adjustable

OPHTHALMIC HEAD SUPPORT



2. AT-OPT-KI^① + AT-OPT-YA/YB^② (1pc/order) (headrest) (Bracket)

Easy to detach and attach, provide secure support for the patient's head

FOR FIXING

CLAMP

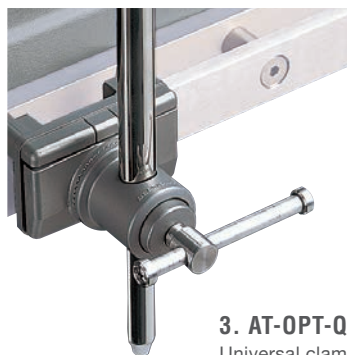

3. AT-OPT-Q (1pc/order)

Universal clamp, direction adjustable



4. AT-OPT-R (1pc/order)

Vertical clamp, height adjustable

FOR X-RAY PHOTOGRAPHY

CASSETTE TRAYS

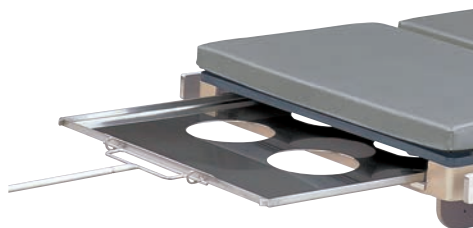

5. AT-OPT-J (1pc/order)

Smooth slide inside the table top



6. AT-OPT-L (1pc/order)

Device for fixing cassette tray (side version) vertical clamp inc.

SCREEN FRAME & OTHER ACCESSORIES

ANESTHETIC SCREEN FRAME



1. AT-OPT-BL (1pc/order)

L shaped screen frame,
vertical clamp inc.



2. AT-OPT-BN (1pc/order)

Gate shaped screen frame,
universal clamp inc.



3. AT-OPT-BN2 (1pc/order)

Peak shaped screen frame,
universal clamp inc.



4. AT-OPT-BN1 (1pc/order)

Fan shaped screen frame,
universal clamp inc.

DOUCHE TRAY



5. AT-OPT-X20/X78/X26S/X37 (1pc/order)

The tray under table top, hanging type (X20), sliding type (X78, X26S, X37)

WASTE WATER TANK



6. AT-OPT-X2 (1pc/order)

Hose connection, 10L size, set up under the operating table

STERILIZED TRAY HOLDER



7. AT-OPT-M (1pc/order)

Gate shaped tray holder, universal angle adjustable
universal clamp inc.



8. AT-OPT-N2 (1pc/order)

L shaped tray holder, horizontal angle adjustable
universal clamp inc.

BAR FOR HANGING CABLE



9. AT-OPT-Z1 (1pc/order)

Height adjustable, one hook
vertical clamp inc.



10. AT-OPT-ZN (1pc/order)

Height and angle adjustable, two hooks
universal clamp inc.

ARM SHIELD



11. AT-OPT-AS2 (1pc/order)

Easy attachment under the table pad,
secure protection, 2 pcs per unit

FOR ORTHOPEDIC SURGERY

BEACH CHAIR POSITIONER



1. BEACH CHAIR POSITIONER : AT-OPT-BCP (1pc/order)

Back panel removable, easy access to the surgical site, angle adjustable from chair to flat position with the handle on back side, easy installation and removal of head positioners



PADS



SECURITY



ARM SUPPORT



COUNTER TRACTION STRAP



CART



HEADREST

VERTEBRA FRAME



2. AT-OPT-T (1pc/order)

Angle adjustable, each frame movable, used for Spine surgery

LUMBAR FRAME



3. AT-OPT-V (1pc/order)

Firmly attached to side rail used for Lumbar treatment

TRACTION UNIT & CART

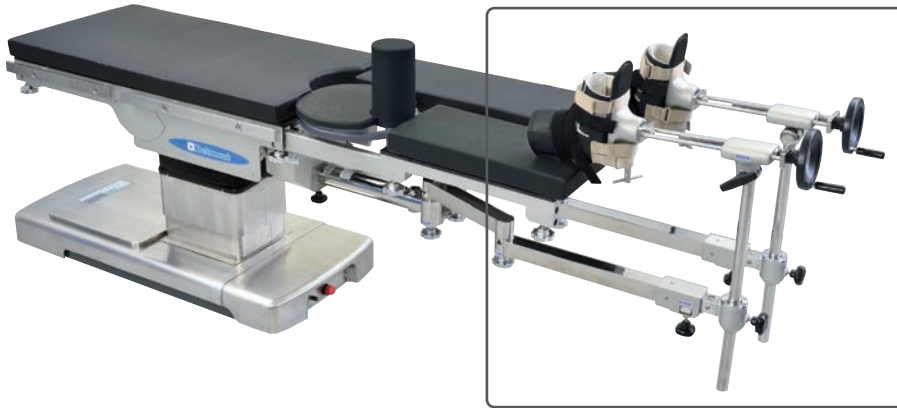

1. DR-3700-A (1pc/order)
(Lower limb traction device)

Smooth setting, securing wide space, little stress in C-Arm installation and no requirement of support bar for traction unit



* Traction device exclusive

2. AT-3700-B (1pc/order)

The cart for traction unit



* Accessories shown in the picture are exclusive

3. AT-OPTM-ACC (1pc/order)

The cart for traction accessories

OPTIONAL ACCESSORIES



1. DR-OPTM-DNW (1pair/order)
Shoulder Support (Wide)
vertical clamp inc.



2. DR-OPTM-EPBS (1pc/order)
Universal side support (Small)
vertical clamp inc.



3. DR-OPTM-WK (1pair/order)
Foot shield without mattress
vertical clamp inc.



4. DR-OPTM-GMAB (1pc/order)
Flexible arm board, direction adjustable, help various positioning
universal clamp inc.



GEL ACCESSORIES ①

ARM ELBOW



MA302



MA304



MA311



MA312



MF461

SHOULDER BODY



MC504



MC541



MC553



MC561



MP604

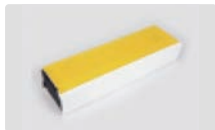

MP631



MP611



MS703

MA301/302

Arm board pad

MA303~306

Arm board pad with contoured design

MA311: 38x12x0.8

Arm protector with adjustable velcro

MA312: 46x21x0.8

Arm protector

MF461: 33x7x1.5

Fastening belt with velcro

MC501~514

Chest roll (Adult)

MC521~541

Chest roll (Pediatric)

MC551~553

Contoured chest roll, support body with two rolls (right and left)

MC561~562-1

Chest positioner, support and protect body with the round shape

MP601~607

Universal patient positioner, support various parts of the body

MP631~635

Patient positioner

MS703

Prone frame set with gel pad and frame, fastened with magic tape

Size: LxWxH (cm)

Arm Board Pad

MA301: 40x12.5x2
MA302: 60x12.5x2
MA303: 40x15x6
MA304: 50x15x6
MA305: 60x15x6
MA306: 63x15x6

Arm Protector

MA311: 38x12x0.8
MA312: 46x21x0.8

Fastening Belt

MF461: 33x7x1.5
MF462: 36x7x1.5

Chest Roll (Adult)

MC501: 15x5x5
MC502: 20x5x5
MC503: 25x5x5
MC504: 30x5x5
MC511: 15x7.5x7.5
MC512: 20x7.5x7.5
MC513: 25x7.5x7.5
MC514: 30x7.5x7.5

Chest Roll (Pediatric)

MC521: 30x10x8.5
MC522: 40x10x8.5
MC523: 50x10x8.5
MC531: 30x15x10
MC532: 40x15x10
MC533: 50x15x10
MC541: 50x18x15

Contoured chest roll

MC551: 30x16x13/9
MC552: 40x16x13/9
MC553: 50x16x13/9

Chest Positioner

MC561(R): 71/58x20x7.6
MC562(L): 71/58x20x7.6
MC561-1(R): 55/47x15x6
MC562-1(L): 55/47x15x6

Universal Patient Positioner

MP601: 16x8x4.5
MP602: 33x7x5
MP603: 33x12x6
MP604: 36x12.5x7
MP605: 25x12.5x5
MP606: 38x12.5x6.3
MP607: 50x12.5x7

Patient Positioner

MP631: 16x8x6
MP632: 70x20x8
MP633: 30x15x10
MP634: 50x15x10
MP635: 60x15x10

Wilson Frame Pad

MS701: 75x25.5x2.5 (2pcs/order)
MS702: 75x25.5x1 (2pcs/order)

Prone Frame Set (MS703+MS704)

MS703: 72.5x17.5x2 (2pcs/order)
(pad) 18.5x12x2
18.5x12x2 w/c
MS704: 60x49x15.5
(frame)

GEL ACCESSORIES ②

TABLE PAD



MT100



MT105



MT142

HEAD



MH204



MH214



MH213C



MH221



MH231



MH232



MH241

MT100~105

The mattress without cut

MT106~111

Cut into three pieces, with a hole in the middle

MT141~144

Embossed operating table pad, protect patient's body from body pressure

MH201~204

Closed head ring, stabilize the head position

MH211~214

Open head ring, easy access of respirator hose

MH211C~213C

Open head ring, width adjustable to any shape of head

MH221/222

Prone headrest, stabilize their head

MH231

Ophthalmic headrest, stabilize and protect the head's occipital area

MH232

Supine headrest, stabilize and protect the head's occipital area

MH241

Contoured headrest, stabilize head, thigh, heel position

Size: LxWxH (cm)

Operating Table Pad

MT100: 193x86x1
 MT101: 183x50x1
 MT102: 183x50x1.5
 MT103: 117x50.8x1
 MT104: 117x50.8x1.5
 MT105: 50.8x23x1

Operating

Table Pad with cut

MT106: 100x50.8x1 w/c
 MT107: 100x50.8x1.5 w/c
 MT108: 50.8x50.8x1 w/c
 MT109: 50.8x50.8x1.5 w/c
 MT110: 117x50.8x1 w/c
 MT111: 117x50.8x1.5 w/c

Operating Table Pad (Part)

MT112: 50.8x50.8x1
 MT113: 50.8x50.8x1.5
 MT121: 99x50x1
 MT122: 50x25x1
 MT123: 50x25x1.5
 MT124: 50x45x1
 MT125: 50x45x1.5
 MT126: 160x43x1
 MT127: 70x50x1.5
 MT128: 70x45x1.5
 MT129: 46x33x1
 MT131: 60x60x2.5
 MT132: 90x50x2.5
 MT133: 75x25x2
 MT134: 100x50.8x1
 MT135: 100x50.8x1.5
 MT136: 66x15x1.3

Embossed Operating Table Pad

MT141: 52x52x1.6
 MT142: 155x52x1.6
 MT143: 40x23x1.6
 MT144: 91x45x1.6

Closed Head Ring

MH201: 9x4x2
 MH202: 14x6x3.5
 MH203: 20x7.5x4.5
 MH204: 20x7.5x7.5

Open Head Ring

MH211: 9x4x2
 MH212: 14x6x3.5
 MH213: 20x7.5x4.5
 MH214: 20x7.5x7.5

Padless Open Head Ring

MH211C: 9x4x2
 MH212C: 14x6x3.5
 MH213C: 20x7.5x4.5

Prone Headrest

MH221: 28x23x14.5
 MH222: 23x19x13

Ophthalmic Headrest

MH231: 27x23x7

Supine Headrest

MH232: 28x24x9

Contoured Headrest:

MH241: 19x19x6

GEL ACCESSORIES ③

HEEL FOOT



MF401

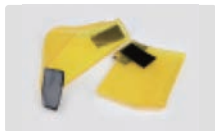

MF404



MF402



MF441

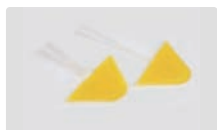

MF403



MP641

MF401

Heel support,
support ankle,
protect heel

MF402

Heel cup, stable heel protector

MF403

Comfort heel cup
(cover heel)

MF404

Comfort heel pad
(cover whole foot)

MF441

Ankle strap,
fix the foot position

MP641

Dome positioner

Size: LxWxH (cm)

Heel Support

MF401: 20x11x7 (2pcs/order)

Heel Cup

MF402: 17x10.5x5 (2pcs/order)

Comfort Heel Cup

MF403: 17x18x1.3 (2pcs/order)

Comfort Heel Pad

MF404: 17x23x1.3 (2pcs/order)

Ankle Strap

MF441: 31x4x1 (4 pcs/order)

Dome Positioner

MP641: 35x15x7.5

* Gel Accessories ①~③ are compatible with all the operating models on back cover.

		DR-2000	DR-2600 series	DR-8800	DR-3700
FOR ARM SUPPORT	AT-OPT-AT	○	○	○	○
	AT-OPT-G	○	○	○	○
	AT-OPT-AW	○	○	○	○
	AT-OPT-AHA	○	○	○	○
	AT-OPT-AHB	○	○	○	○
	AT-OPT-AHZ	○	○	○	○
	AT-OPT-AI	○	○	○	○
	AT-OPT-AIS	○	○	○	○
FOR LEG SUPPORT	BEL FLEX	○	○	○	○
	AT-OPT-CN	○	○	○	○
	AT-OPT-S	—	○	○	○
	AT-OPT-W	—	○	○	○
FOR BODY SUPPORT	AT-OPT-E	○	○	○	○
	AT-OPT-EN	○	○	○	○
	AT-OPT-DN	○	○	○	○
	AT-OPT-EWB	○	○	○	○
	AT-OPT-YKA/YKB	○	○	○	○
	AT-OPT-PA	○	○	○	○
	AT-OPT-PB	○	○	○	○
	AT-OPT-F	—	○	○	○
FOR HEAD SUPPORT	AT-OPT-H	—	○	○	○
	AT-OPT-KI	—	○	○	○
FOR FIXING	AT-OPT-Q	○	○	○	○
	AT-OPT-R	○	○	○	○

		DR-2000	DR-2600 series	DR-8800	DR-3700
FOR X-RAY	AT-OPT-J	—	○	○	○
	AT-OPT-K	—	○	○	○
	AT-OPT-L	○	○	○	○
SCREEN FRAME & OTHER ACCESSORIES	AT-OPT-BL	○	○	○	○
	AT-OPT-BN	○	○	○	○
	AT-OPT-BN2	○	○	○	○
	AT-OPT-BN1	○	○	○	○
	AT-OPT-X20/78/26S/37	○	○	—	○
	AT-OPT-X2	○	○	○	○
	AT-OPT-M	○	○	○	○
	AT-OPT-N2	○	○	○	○
	AT-OPT-Z1	○	○	○	○
	AT-OPT-ZN	○	○	○	○
	AT-OPT-AS	○	○	○	○
FOR ORTHOPEDIC SURGERY	BEACH CHAIR POSITIONER	—	—	○	○
	AT-OPT-T	—	○	○	○
	AT-OPT-V	—	○	○	○
TRACTION UNIT & CART	DR-3700-A	—	—	—	○
	AT-3700-B	—	—	—	○
	AT-OPTM-ACC	○	○	○	○
OPTIONAL ACCESSORIES	DR-OPTM-DNW	○	○	○	○
	DR-OPTM-EPBS	○	○	○	○
	DR-OPTM-WK	—	○	○	○
	DR-OPTM-GMAB	○	○	○	○
OPTIONAL ACCESSORIES	AT-OPT-FSW	○ w/o Table Slide	○ w/o Table Slide	○	○
	AT-OPT-HS26/26S/HS88	○	○	○	○



<https://www.takarabelmont.co.jp/english/medical/index.html>

TAKARA BELMONT CORPORATION 2-1-1,HIGASHISHINSAIBASHI,CHUO-KU,OSAKA,542-0083,JAPAN +81-6-6213-5945

The specifications and colors are subject to change without notice.

REF M-016